

CLASSIC BRASS

JAMESTOWN, NEW YORK

INTERIOR LEVER SETS

SHORE COLLECTION

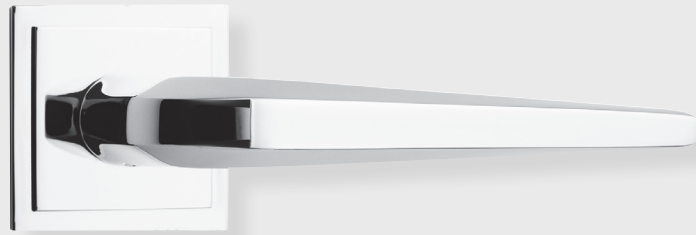

INTERIOR LEVER SETS

2" ROSE SETS

- 17752 Lever Set - PASSAGE
- 17753 Lever Set - PRIVACY
- 17754 Lever Set - SECTIONAL PRIVACY
- 17755 Lever Set - FULL DUMMY
- 17756 Lever Set - HALF DUMMY

- 17757 Lever Mortise Set - PASSAGE
- 17758 Lever Mortise Set - PRIVACY

2-1/2" ROSE SETS

- 17762 Lever Set - PASSAGE
- 17763 Lever Set - PRIVACY
- 17764 Lever Set - SECTIONAL PRIVACY
- 17765 Lever Set - FULL DUMMY
- 17766 Lever Set - HALF DUMMY

- 17750 Lever Only 4-1/2"
- 17676 Square Rose Only 2"
- 17677 Square Rose Only 2-1/2"

MATERIALS

Solid Brass

SPINDLES

8mm SQ (standard)

HOW TO ORDER

1. Specify application.
2. Specify if pre-drilled adapters are required (part #9749).
3. Specify finish. If split finish is required, please indicate exterior/interior.
4. Specify door thickness. Standard thickness is 1-3/8".
5. Specify backset.
 - standard is 2-3/8" for tubular.
 - standard is 2-1/2" for mortise.
6. Specify hand of door - RH/LH for mortise applications.

REMEMBER

1. Specify pre-drilled adapter (#9749) for 2-1/8" pre-drilled doors, which requires the large rose.
2. Specify interior mortise lock for quality installations.
3. All knobs and levers are interchangeable.
4. FULL LIP strikes are standard. Specify SUB "T" strike, if required.
5. A door thickness greater than 1-3/4" will require a #9900 thick door kit for mortise application.
6. Combination strike and faceplate available for sectional tubular privacy function.

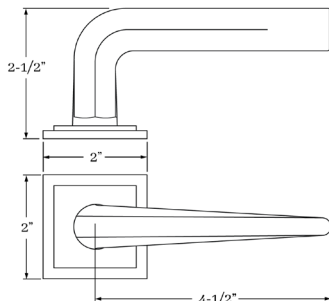

SHORE | DOOR

SET COMPONENTS

Lever Set - PASSAGE includes two rosettes (passage), two levers, passage latch L x L (2-3/8" backset), full lip strike, latch faceplate, 4" straight spindle (8mm), two rosette mount plates, two rosette mount plate hubs, dust box and mounting hardware. NOTE: if required, order pre-drilled adapter (part #9749) separately.

Lever Set - PRIVACY includes two rosettes (privacy), two levers, privacy latch L x L (2-3/8" backset), full lip strike, latch faceplate, 4" swivel spindle (8mm), two rosette mount plates, two rosette mount plate hubs, privacy pin, dust box and mounting hardware. NOTE: if required, order pre-drilled adapter (part #9749) separately.

Lever Set - FULL DUMMY includes two rosettes, two levers, 4" straight spindle (8mm), two dummy rosette mount plates, two rosette mount plate hubs and mounting hardware.

Lever Set - HALF DUMMY includes rosette, lever, dummy mount spindle, rosette mount plate hub and mounting hardware.

Lever Mortise Set - PASSAGE includes two rosettes, two levers, 4" straight spindle (8mm), Accurate 9825 L x L interior mortise lock (2-1/2" backset), strike, faceplate, dust box and mounting hardware.

Lever Mortise Set - PRIVACY includes two rosettes, two levers, turnpiece and backplate, emergency egress trim, 4" straight spindle (8mm), Accurate 9839 L x L interior mortise lock (2-1/2" backset), strike, faceplate, dust box and mounting hardware.

CLASSIC BRASS

JAMESTOWN, NEW YORK

CLASSIC BRASS

JAMESTOWN, NEW YORK

SIGNATURE FINISHES

SOLID BRASS FINISHES



ANTIQUE BRASS
(AB)



ANTIQUE BURNISHED
BRASS (ABB)



ANTIQUE BURNISHED
NICKEL (ABN)



ANTIQUE NICKEL
(AN)



ANTIQUE POLISHED
SILVER (APS)



BURNISHED BRASS
(BB)



BURNISHED NICKEL
(BN)



OIL RUBBED
BRONZE (BZ)



KENSINGTON
(KN)



MATTE BLACK
(MB)



POLISHED ANTIQUE
(PA)



POLISHED ANTIQUE
NO LACQUER (PANL)



POLISHED BRASS
(PB)



POLISHED BRASS
NO LACQUER (PBNL)



POLISHED CHROME
(PC)



POLISHED GOLD
(PG)



POLISHED NICKEL
(PN)



POLISHED SILVER
(PS)



REVERE BRASS
(RB)



REVERE NICKEL
(RN)



REVERE TARNISHED
(RT)



SATIN BRASS
(SB)



SATIN BRASS
NO LACQUER (SBNL)



SATIN GOLD
(SG)



SATIN NICKEL
(SN)



SATIN SILVER
(SS)



SATIN TARNISHED
(STN)



TARNISHED
(TN)



WEATHERED ANTIQUE
NICKEL (WA)



WEATHERED BRASS
(WB)



WEATHERED BRONZE
(WZ)



WEATHERED COPPER
(WC)



WEATHERED NICKEL
(WN)

LEVEL 1

Antique Brass (AB)
Antique Burnished Brass (ABB)
Antique Revere Brass (ARB)
Burnished Brass (BB)
Oil Rubbed Bronze (BZ)
Kensington (KN)
Polished Antique (PA)
Polished Antique — No Lacquer (PANL)
Polished Brass (PB)
Polished Brass — No Lacquer (PBNL)
Revere Brass (RB)
Revere Tarnished (RT)
Satin Brass (SB)
Satin Brass — No Lacquer (SBNL)
Tarnished (TN)
Weathered Brass (WB)
Weathered Bronze (WZ)

LEVEL 2

Antique Burnished Nickel (ABN)
Antique Revere Nickel (ARN)
Antique Nickel (AN)
Burnished Nickel (BN)
Matte Black (MB)
Polished Chrome (PC)
Polished Nickel (PN)
Revere Nickel (RN)
Satin Nickel (SN)
Weathered Antique Nickel (WA)
Weathered Copper (WC)
Weathered Nickel (WN)

LEVEL 3

Antique Polished Silver (APS)
Antique Revere Silver (ARS)
Polished Silver (PS)
Revere Silver (RS)
Satin Silver (SS)

PRICE ON REQUEST

Polished Gold (PG)
Satin Gold (SG)

Custom finishes available on request.