

# CLASSIC BRASS

JAMESTOWN, NEW YORK

## INTERIOR LEVER SETS

---

FIFTH AVENUE COLLECTION



# INTERIOR LEVER SETS

## APPLICATIONS

- 7734 Lever Set - PASSAGE
- 7742 Lever Set - PRIVACY
- 7750 Lever Set - FULL DUMMY
- 7758 Lever Set - HALF DUMMY

- 7773 Lever Only 3-13/16"
- 7778 Square Rose Only 2"

## PRODUCT DIMENSIONS

- Lever 3-13/16"
- Rose 2"

## MATERIALS

Solid Brass

## SPINDLES

8mm SQ (standard)

## HOW TO ORDER

1. Specify application.
2. Specify if pre-drilled adapters are required (part #9749).
3. Specify finish. If split finish is required, please indicate exterior/interior.
4. Specify door thickness. Standard thickness is 1-3/8".
5. Specify backset.
  - standard is 2-3/8" for tubular.
  - standard is 2-1/2" for mortise.
6. Specify hand of door - RH/LH for mortise applications.

## REMEMBER

1. Specify pre-drilled adapter (#9749) for 2-1/8" pre-drilled doors, which requires the large rose.
2. Consider utilizing an interior mortise lock for quality installations.
3. All knobs and levers are interchangeable.
4. FULL LIP strikes are standard. Specify SUB "T" strike, if required.
5. Standard backset is 2-3/8" for tubular. If required, specify 2-3/4".

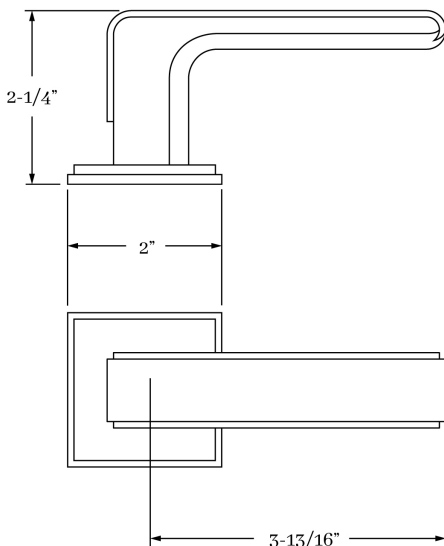

FIFTH AVENUE | DOOR

## SET COMPONENTS

**Lever Set - PASSAGE** includes two rosettes (passage), two levers, passage latch L x L (2-3/8" backset), full lip strike, latch faceplate, 4" straight spindle (8mm), two rosette mount plates, two rosette mount plate hubs, dust box and mounting hardware. NOTE: if required, order pre-drilled adapter (part #9749) separately.

**Lever Set - PRIVACY** includes two rosettes (privacy), two levers, privacy latch L x L (2-3/8" backset), full lip strike, latch faceplate, 4" swivel spindle (8mm), two rosette mount plates, two rosette mount plate hubs, privacy pin, dust box and mounting hardware. NOTE: if required, order pre-drilled adapter (part #9749) separately.

**Lever Set - FULL DUMMY** includes two rosettes, two levers, 4" straight spindle (8mm), two dummy rosette mount plates, two rosette mount plate hubs and mounting hardware.

**Lever Set - HALF DUMMY** includes rosette, lever, dummy mount spindle, rosette mount plate hub and mounting hardware.

CLASSIC BRASS

JAMESTOWN, NEW YORK

SQUARE ESCUTCHEON  
EDGE OPTIONS

**ONE STEP EDGE**  
Standard

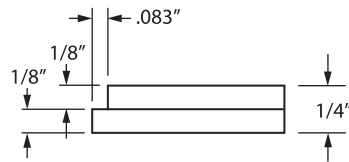
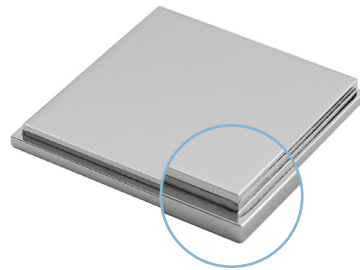

**TWO STEP EDGE**

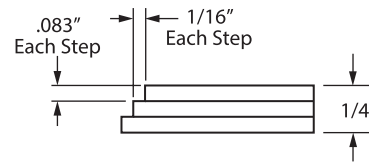
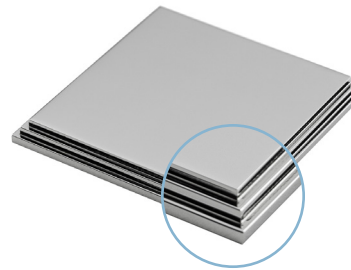

**BEVEL EDGE**

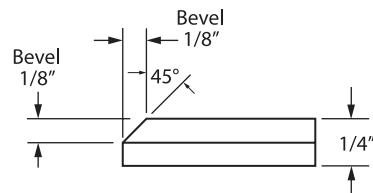
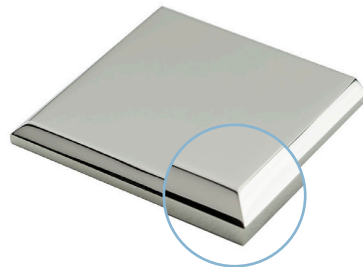

**SLAB EDGE**

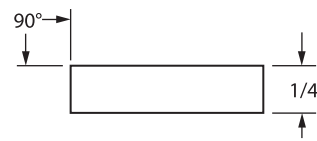

**HOW TO ORDER**

- Specify EDGE DETAIL — ONE STEP edge option is standard. If alternate EDGE DETAIL is required — make sure to specify as SUB (example — SUB BEVEL).

**REMEMBER**

- Custom escutcheon sizes are available.
- Standard escutcheon thickness is 1/4" — alternate thickness available upon request.
- Contact us to discuss custom edge details or profiles.

# CLASSIC BRASS

JAMESTOWN, NEW YORK

## SIGNATURE FINISHES

### SOLID BRASS FINISHES

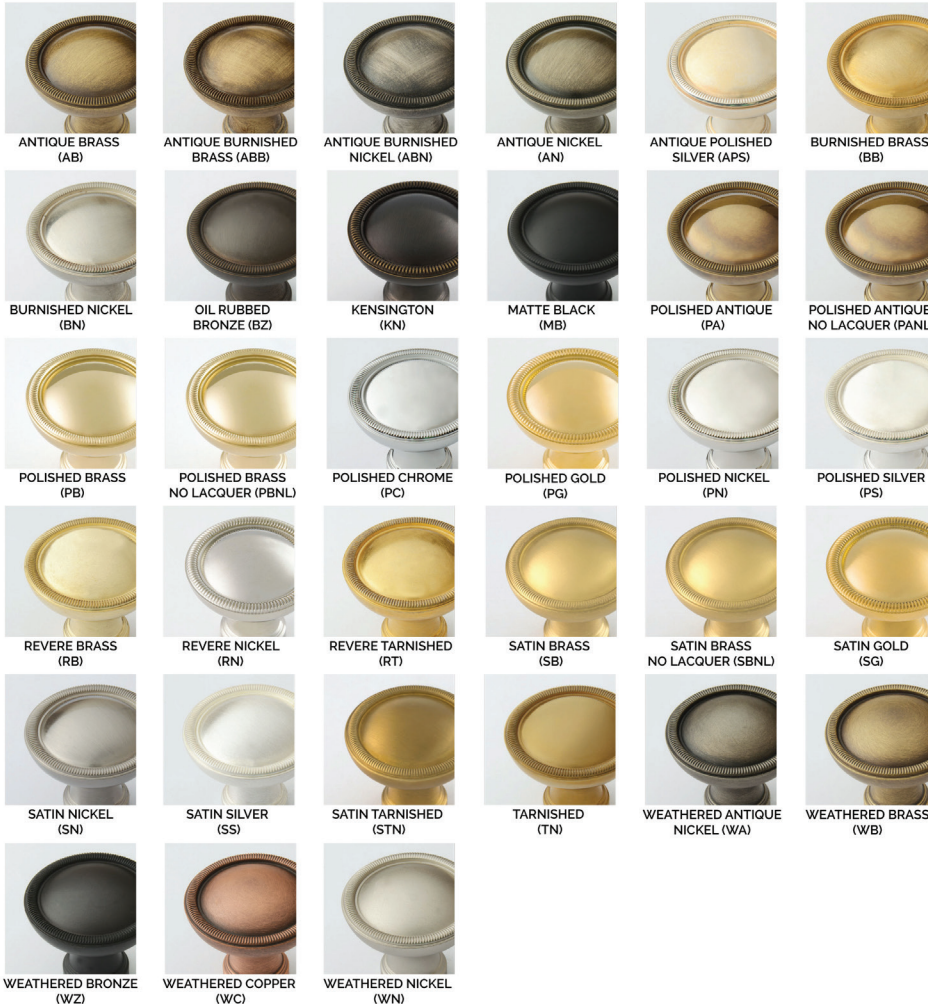

### LEVEL 1

- Antique Brass (AB)
- Antique Burnished Brass (ABB)
- Burnished Brass (BB)
- Oil Rubbed Bronze (BZ)
- Kensington (KN)
- Polished Antique (PA)
- Polished Antique — No Lacquer (PANL)
- Polished Brass (PB)
- Polished Brass — No Lacquer (PBNL)
- Revere Brass (RB)
- Revere Tarnished (RT)
- Satin Brass (SB)
- Satin Brass — No Lacquer (SBNL)
- Tarnished (TN)
- Weathered Brass (WB)
- Weathered Bronze (WZ)

### LEVEL 2

- Antique Burnished Nickel (ABN)
- Antique Nickel (AN)
- Burnished Nickel (BN)
- Matte Black (MB)
- Polished Chrome (PC)
- Polished Nickel (PN)
- Revere Nickel (RN)
- Satin Nickel (SN)
- Weathered Antique Nickel (WA)
- Weathered Copper (WC)
- Weathered Nickel (WN)

### LEVEL 3

- Antique Polished Silver (APS)
- Polished Silver (PS)
- Satin Silver (SS)

### PRICE ON REQUEST

- Polished Gold (PG)
- Satin Gold (SG)

Custom finishes available on request.