

CLASSIC BRASS

JAMESTOWN, NEW YORK

PULL PLATES

FIFTH AVENUE COLLECTION



PULL PLATES

APPLICATIONS

7685 Pull Plate 2-1/2" x 14" (P) 7689

7686 Pull Plate 3" x 21" (P) 7689

7687 Pull Plate 3" x 21" (P) 7690

MATERIALS

Solid Brass

HOW TO ORDER

1. Specify application.
2. Specify finish.
3. Specify door thickness. Standard is 1-3/4".

REMEMBER

1. Back-to-back applications available for pulls and pull plates. Specify #9958 for BTB and #9959 for Single Sided mounting.
2. Custom escutcheon sizes and drilling available.
3. ONE STEP edge profile is standard. Specify TWO STEP, BEVEL, or SLAB edge profile if required.



FIFTH AVENUE | DOOR

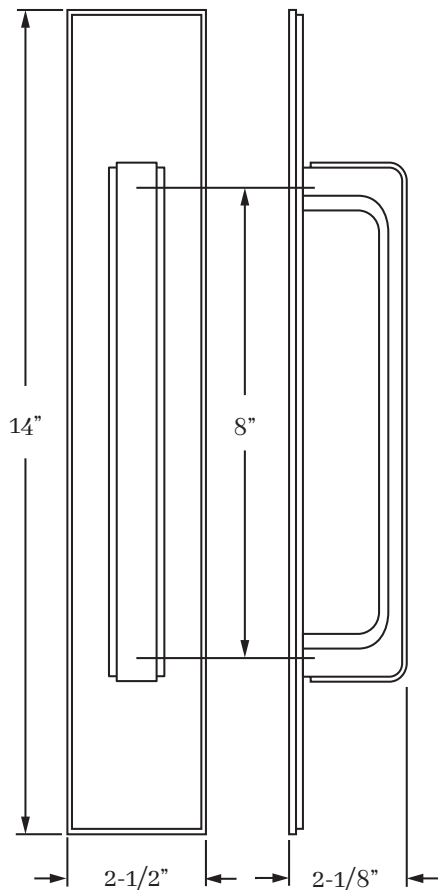

SET COMPONENTS

Pull Plate Only includes one pull mounted to plate and mounting hardware.

CLASSIC BRASS
JAMESTOWN, NEW YORK

SQUARE ESCUTCHEON
EDGE OPTIONS

ONE STEP EDGE
Standard

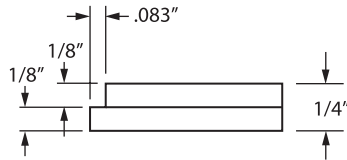
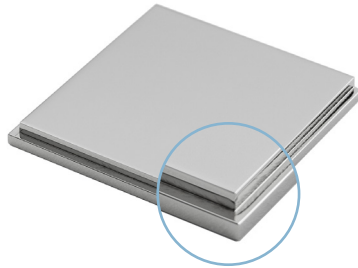

TWO STEP EDGE

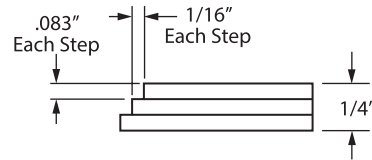
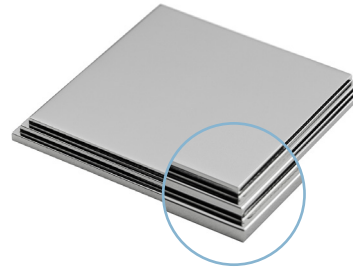

BEVEL EDGE

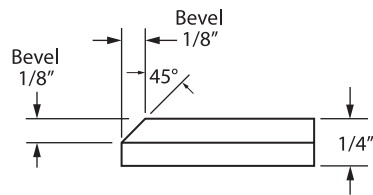
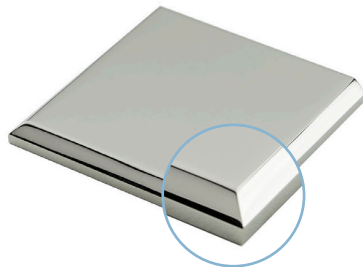

SLAB EDGE

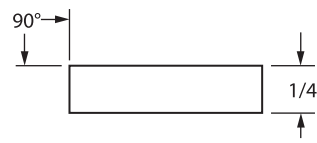

HOW TO ORDER

- Specify edge detail — ONE STEP edge option is standard. If alternate edge detail is required — make sure to specify as SUB (example — SUB BEVEL).

REMEMBER

- Custom escutcheon sizes are available.
- Standard escutcheon thickness is 1/4" — alternate thickness available upon request.
- Contact us to discuss custom edge details or profiles.

CLASSIC BRASS

JAMESTOWN, NEW YORK

SIGNATURE FINISHES

SOLID BRASS FINISHES



LEVEL 1

- Antique Brass (AB)
- Antique Burnished Brass (ABB)
- Burnished Brass (BB)
- Oil Rubbed Bronze (BZ)
- Kensington (KN)
- Polished Antique (PA)
- Polished Antique — No Lacquer (PANL)
- Polished Brass (PB)
- Polished Brass — No Lacquer (PBNL)
- Revere Brass (RB)
- Revere Tarnished (RT)
- Satin Brass (SB)
- Satin Brass — No Lacquer (SBNL)
- Tarnished (TN)
- Weathered Brass (WB)
- Weathered Bronze (WZ)

LEVEL 2

- Antique Burnished Nickel (ABN)
- Antique Nickel (AN)
- Burnished Nickel (BN)
- Matte Black (MB)
- Polished Chrome (PC)
- Polished Nickel (PN)
- Revere Nickel (RN)
- Satin Nickel (SN)
- Weathered Antique Nickel (WA)
- Weathered Copper (WC)
- Weathered Nickel (WN)

LEVEL 3

- Antique Polished Silver (APS)
- Polished Silver (PS)
- Satin Silver (SS)

PRICE ON REQUEST

- Polished Gold (PG)
- Satin Gold (SG)

Custom finishes available on request.