

# CLASSIC BRASS

JAMESTOWN, NEW YORK

## M/P SETS - EURO SECTIONAL

---

HUTTER COLLECTION



# M/P - EURO SECTIONAL

## APPLICATIONS

- 7230 Lever Euro M/P Sectional Set - ENTRANCE
- 7231 Lever Euro M/P Sectional Set - FULL DUMMY
- 7232 Lever Euro M/P Sectional Set - ACTIVE DUMMY
- 7233 Lever Euro M/P Sectional Set - PATIO

Above sets include 7973 Lever

## MATERIALS

Solid Brass

## HOW TO ORDER

1. Specify application.
2. Specify finish. If split finish is required, please indicate exterior/interior.
3. Specify door thickness. Standard thickness is 1-3/4".
4. Specify hand of door - RH/LH.
5. Specify fixed or active exterior lever when ordering active dummy set.

## REMEMBER

1. VERIFY door prep will be fully covered by sectional trim.
2. Standard euro profile application is LEVER HIGH - 92mm (hub-cylinder spacing).
3. Door thickness greater than 1-3/4" will require longer euro cylinders and/or offset cylinders. 62mm K x T/P (31mm x 31mm) and 31mm Half Cylinder is standard for 1-3/4" doors.
4. Cylinders INCLUDED with all applications (collection turnpiece attached).
5. Custom rose and cylinder collar sizes available.
6. Strike not included.
7. Euro offset cylinders and custom lengths available upon request.



HUTTER | DOOR

## SET COMPONENTS

**Lever Euro M/P Sectional Set - ENTRANCE** includes two rosettes, two levers, 4" straight spindle (8mm), euro profile cylinder - 62mm - K x TP and surface mounting screws.

**Lever Euro M/P Sectional Set - FULL DUMMY** includes two rosettes, two levers, 4" straight spindle (8mm), full dummy mounting hardware and surface mounting screws.

**Lever Euro M/P Sectional Set - ACTIVE DUMMY** includes two rosettes, two levers, 4" swivel spindle (8mm), full dummy mounting hardware for exterior rosette.

**Lever Euro M/P Sectional Set - PATIO** includes two rosettes, two levers, one euro cylinder collar, euro profile half cylinder (31mm), 4" straight spindle (8mm) and surface mounting screws.

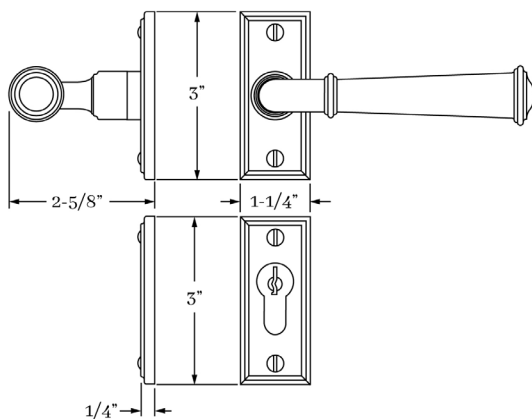

CLASSIC BRASS

JAMESTOWN, NEW YORK

# CLASSIC BRASS

JAMESTOWN, NEW YORK

## SIGNATURE FINISHES

### SOLID BRASS FINISHES



ANTIQUE BRASS  
(AB)



ANTIQUE BURNISHED  
BRASS (ABB)



ANTIQUE BURNISHED  
NICKEL (ABN)



ANTIQUE NICKEL  
(AN)



ANTIQUE POLISHED  
SILVER (APS)



BURNISHED BRASS  
(BB)



BURNISHED NICKEL  
(BN)



OIL RUBBED  
BRONZE (BZ)



KENSINGTON  
(KN)



MATTE BLACK  
(MB)



POLISHED ANTIQUE  
(PA)



POLISHED ANTIQUE  
NO LACQUER (PANL)



POLISHED BRASS  
(PB)



POLISHED BRASS  
NO LACQUER (PBNL)



POLISHED CHROME  
(PC)



POLISHED GOLD  
(PG)



POLISHED NICKEL  
(PN)



POLISHED SILVER  
(PS)



REVERE BRASS  
(RB)



REVERE NICKEL  
(RN)



REVERE TARNISHED  
(RT)



SATIN BRASS  
(SB)



SATIN BRASS  
NO LACQUER (SBNL)



SATIN GOLD  
(SG)



SATIN NICKEL  
(SN)



SATIN SILVER  
(SS)



SATIN TARNISHED  
(STN)



TARNISHED  
(TN)



WEATHERED ANTIQUE  
NICKEL (WA)



WEATHERED BRASS  
(WB)



WEATHERED BRONZE  
(WZ)



WEATHERED COPPER  
(WC)



WEATHERED NICKEL  
(WN)

### LEVEL 1

Antique Brass (AB)  
Antique Burnished Brass (ABB)  
Burnished Brass (BB)  
Oil Rubbed Bronze (BZ)  
Kensington (KN)  
Polished Antique (PA)  
Polished Antique — No Lacquer (PANL)  
Polished Brass (PB)  
Polished Brass — No Lacquer (PBNL)  
Revere Brass (RB)  
Revere Tarnished (RT)  
Satin Brass (SB)  
Satin Brass — No Lacquer (SBNL)  
Tarnished (TN)  
Weathered Brass (WB)  
Weathered Bronze (WZ)

### LEVEL 2

Antique Burnished Nickel (ABN)  
Antique Nickel (AN)  
Burnished Nickel (BN)  
Matte Black (MB)  
Polished Chrome (PC)  
Polished Nickel (PN)  
Revere Nickel (RN)  
Satin Nickel (SN)  
Weathered Antique Nickel (WA)  
Weathered Copper (WC)  
Weathered Nickel (WN)

### LEVEL 3

Antique Polished Silver (APS)  
Polished Silver (PS)  
Satin Silver (SS)

### PRICE ON REQUEST

Polished Gold (PG)  
Satin Gold (SG)

Custom finishes available on request.