

CLASSIC BRASS

JAMESTOWN, NEW YORK

KNOB AND ESCUTCHEON

CHAUTAUQUA COLLECTION



KNOB AND ESCUTCHEON

2-1/2" x 12" ESCUTCHEON SETS

13660 Knob Escutcheon Set - PASSAGE

13661 Knob Escutcheon Set - PRIVACY

13662 Knob Escutcheon Set - LATCH x M/B

13663 Knob Escutcheon Set - FULL DUMMY

13664 Knob Escutcheon Set - HALF DUMMY

13665 Knob Escutcheon Mortise Set - PASSAGE

13666 Knob Escutcheon Mortise Set - PRIVACY

Above sets include 14240 Knob

MATERIALS

Solid Brass

SPINDLES

8mm SQ (standard)

HOW TO ORDER

1. Specify application.
2. Specify finish. If split finish is required, please indicate exterior/interior.
3. Specify door thickness. Standard thickness is 1-3/4".
4. Specify hand of door - RH/LH.
5. Specify backset.
 - standard is 2-3/8" for tubular.
 - standard is 2-1/2" for mortise.

REMEMBER

1. Specify interior mortise lock for quality installations.
2. All knobs are interchangeable.
3. FULL LIP strikes are standard. Specify SUB "T" strike, if required.
4. Standard backset is 2-3/8" for tubular. If required, specify 2-3/4".
5. A door thickness greater than 1-3/4" will require a #9900 thick door kit for mortise application.
6. Custom escutcheon sizes and drilling available.
7. CHAUTAUQUA SQUARE edge profile is standard. Additional edge details available.
8. Combination strike and faceplate available for latch x mortise bolt function.
9. Concealed undermount attachment is standard on exterior escutcheon. Oval slot head machine screws (2/ea) are standard on interior escutcheon.

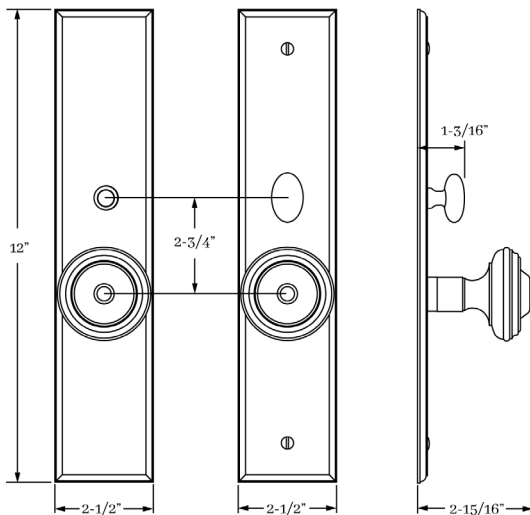

SET COMPONENTS

Knob Escutcheon Set - PASSAGE includes two escutcheons, two knobs, 4" straight spindle (8mm), passage latch K x K (2-3/8" backset), faceplate, full lip strike, dust box and mounting hardware.

Knob Escutcheon Set - PRIVACY includes two escutcheons with privacy pin hole, two knobs, 4" swivel spindle (8mm), privacy latch K x K (2-3/8" backset), privacy pin, faceplate, full lip strike, dust box and mounting hardware.

Knob Escutcheon Set - LATCH x MORTISE BOLT includes an exterior escutcheon w/ EE hole, an interior escutcheon w/ turnpiece attached, two knobs, 4" straight spindle (8mm), passage latch K x K (2-3/8" backset) latch faceplate, full lip strike, mortise bolt (2-3/8" backset), mortise bolt faceplate, mortise bolt strike, dust boxes and mounting hardware. NOTE: our standard spacing between knob hub and mortise bolt is 2-3/4".

Knob Escutcheon Set - FULL DUMMY includes two escutcheons, two knobs, 4" straight spindle (8mm), two dummy mounting plates and mounting hardware.

Knob Escutcheon Set - HALF DUMMY includes an escutcheon, knob, dummy mount spindle and mounting hardware.

Knob Escutcheon Mortise Set - PASSAGE includes two escutcheons, two knobs, 4" straight spindle (8mm), Accurate 9825 K x K interior mortise lock (2-1/2" backset), strike, faceplate, dust box and mounting hardware.

Knob Escutcheon Mortise Set - PRIVACY includes an exterior escutcheon w/ EE hole, an interior escutcheon w/ turnpiece attached, two knobs, 4" straight spindle (8mm), Accurate 9839 K x K interior mortise lock (2-1/2" backset), strike, faceplate, dust box and mounting hardware.

SQUARE ESCUTCHEON
EDGE OPTIONS

CHAUTAUQUA EDGE
Standard

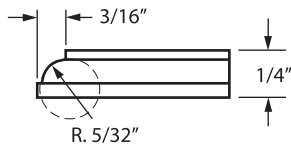
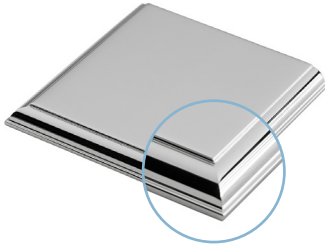

COIN EDGE

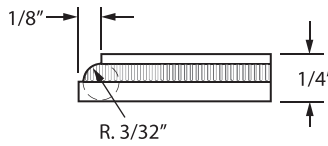
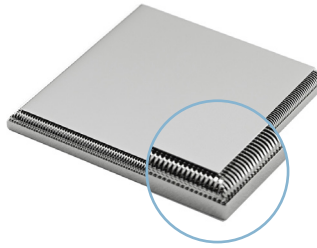

ROPE EDGE

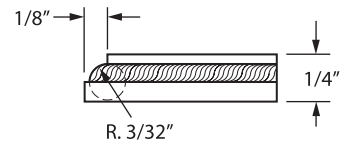
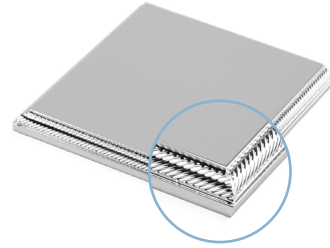

BEVEL EDGE

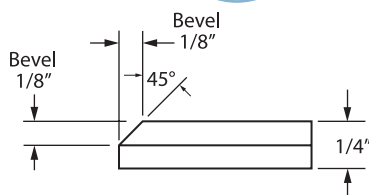
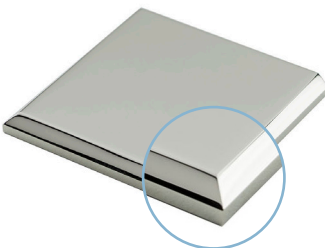

SLAB EDGE

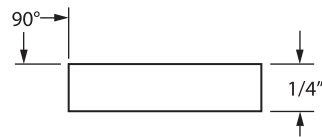

ROLLED EDGE

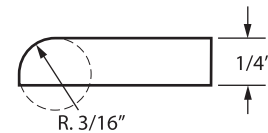

HOW TO ORDER

- Select correct series of profile required (i.e. EYEBROW or SQUARE).
- Specify EDGE DETAIL – CHAUTAUQUA edge option is standard. If alternate EDGE DETAIL is required – make sure to specify as SUB (example – SUB ROPE).
- If necessary, calculate the appropriate upcharge per lineal inch for COIN or ROPE (see retail price list).

REMEMBER

- Custom escutcheon sizes are available.
- Standard escutcheon thickness is 1/4" – alternate thickness available upon request.
- Contact us to discuss custom edge details or profiles.

CLASSIC BRASS

JAMESTOWN, NEW YORK

SIGNATURE FINISHES

SOLID BRASS FINISHES



ANTIQUE BRASS
(AB)



ANTIQUE BURNISHED
BRASS (ABB)



ANTIQUE BURNISHED
NICKEL (ABN)



ANTIQUE NICKEL
(AN)



ANTIQUE POLISHED
SILVER (APS)



BURNISHED BRASS
(BB)



BURNISHED NICKEL
(BN)



OIL RUBBED
BRONZE (BZ)



KENSINGTON
(KN)



MATTE BLACK
(MB)



POLISHED ANTIQUE
(PA)



POLISHED ANTIQUE
NO LACQUER (PANL)



POLISHED BRASS
(PB)



POLISHED BRASS
NO LACQUER (PBNL)



POLISHED CHROME
(PC)



POLISHED GOLD
(PG)



POLISHED NICKEL
(PN)



POLISHED SILVER
(PS)



REVERE BRASS
(RB)



REVERE NICKEL
(RN)



REVERE TARNISHED
(RT)



SATIN BRASS
(SB)



SATIN BRASS
NO LACQUER (SBNL)



SATIN GOLD
(SG)



SATIN NICKEL
(SN)



SATIN SILVER
(SS)



SATIN TARNISHED
(STN)



TARNISHED
(TN)



WEATHERED ANTIQUE
NICKEL (WA)



WEATHERED BRASS
(WB)



WEATHERED BRONZE
(WZ)



WEATHERED COPPER
(WC)



WEATHERED NICKEL
(WN)

LEVEL 1

Antique Brass (AB)
Antique Burnished Brass (ABB)
Burnished Brass (BB)
Oil Rubbed Bronze (BZ)
Kensington (KN)
Polished Antique (PA)
Polished Antique — No Lacquer (PANL)
Polished Brass (PB)
Polished Brass — No Lacquer (PBNL)
Revere Brass (RB)
Revere Tarnished (RT)
Satin Brass (SB)
Satin Brass — No Lacquer (SBNL)
Tarnished (TN)
Weathered Brass (WB)
Weathered Bronze (WZ)

LEVEL 2

Antique Burnished Nickel (ABN)
Antique Nickel (AN)
Burnished Nickel (BN)
Matte Black (MB)
Polished Chrome (PC)
Polished Nickel (PN)
Revere Nickel (RN)
Satin Nickel (SN)
Weathered Antique Nickel (WA)
Weathered Copper (WC)
Weathered Nickel (WN)

LEVEL 3

Antique Polished Silver (APS)
Polished Silver (PS)
Satin Silver (SS)

PRICE ON REQUEST

Polished Gold (PG)
Satin Gold (SG)

Custom finishes available on request.