

CLASSIC BRASS

JAMESTOWN, NEW YORK

M/P SETS - EURO

CHAUTAUQUA COLLECTION



M/P SETS - EURO

1-1/2" X 10" MULTI POINT SETS

- 13305 Lever Euro M/P Set - ENTRANCE
- 13306 Lever Euro M/P Set - FULL DUMMY
- 13307 Lever Euro M/P Set - ACTIVE DUMMY
- 13308 Lever Euro M/P Set - PATIO

Above sets include 16080 Lever

2" X 11" MULTI POINT SETS

- 13315 Lever Euro M/P Set - ENTRANCE
- 13316 Lever Euro M/P Set - FULL DUMMY
- 13317 Lever Euro M/P Set - ACTIVE DUMMY
- 13318 Lever Euro M/P Set - PATIO

Above sets include 16080 Lever

2-1/2" X 12" MULTI POINT SETS

- 13325 Lever Euro M/P Set - ENTRANCE
- 13326 Lever Euro M/P Set - FULL DUMMY
- 13327 Lever Euro M/P Set - ACTIVE DUMMY
- 13328 Lever Euro M/P Set - PATIO

Above sets include 16080 Lever

MATERIALS

Solid Brass

SPINDLES

8mm SQ (standard)

HOW TO ORDER

1. Specify application.
2. See our M/P Check Sheet (Form 500) for additional information.
3. Specify finish. If split finish is required, please indicate exterior/interior.
4. Specify door thickness. Standard thickness is 1-3/4".
5. Specify hand of door - RH/LH.
6. Specify fixed or active exterior lever when ordering active dummy set.

REMEMBER

1. Complete our M/P Check Sheet (Form 500).
2. Standard euro profile application is LEVER HIGH - 92mm (hub-cylinder spacing).
3. All levers are interchangeable.
4. Door thickness greater than 1-3/4" will require longer euro cylinders and/or offset cylinders. 62mm x K x TP (31mm x 31mm) and 31mm Half Cylinder is standard for 1-3/4" doors.
5. Cylinders INCLUDED with all applications (collection turnpiece attached).
6. Strike not included.
7. Custom escutcheon sizes and drilling available.
8. CHAUTAUQUA EYEBROW edge profile is standard. Additional edge details available.
9. Euro offset cylinders and custom lengths available upon request.

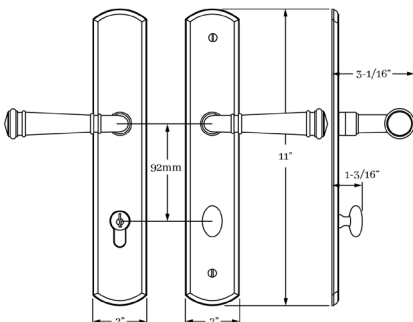

CHAUTAUQUA | DOOR

SET COMPONENTS

Lever Euro M/P Set - ENTRANCE includes two escutcheons, two levers, 4" straight spindle (8mm), euro profile cylinder - 62mm - K x TP and mounting hardware. NOTE: our standard spacing between lever hub and the profile cylinder is 92mm.

Lever Euro M/P Set - FULL DUMMY includes two escutcheons, two levers, 4" straight spindle (8mm), two dummy mount plates and mounting hardware.

Lever Euro M/P Set - ACTIVE DUMMY includes two escutcheons, two levers, 4" swivel spindle (8mm), dummy mount plates for exterior and mounting hardware.

Lever Euro M/P Set - PATIO includes exterior escutcheon, interior escutcheon, two levers, 4" straight spindle (8mm), euro profile half cylinder - 31mm and mounting hardware. NOTE: our standard spacing between lever hub and the profile cylinder is 92mm.

CLASSIC BRASS

JAMESTOWN, NEW YORK

EYEBROW ESCUTCHEON
EDGE OPTIONS

CHAUTAUQUA EDGE
Standard

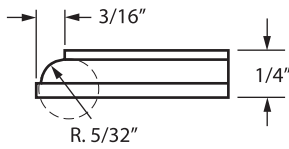
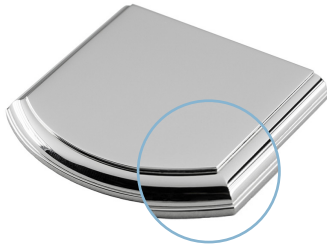

COIN EDGE

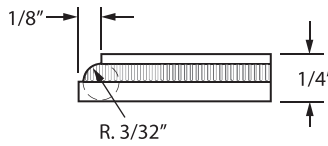
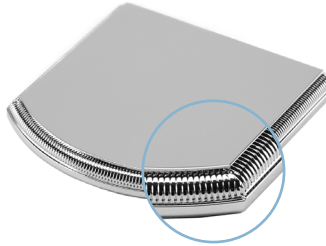

ROPE EDGE

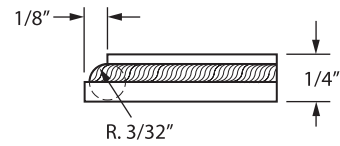
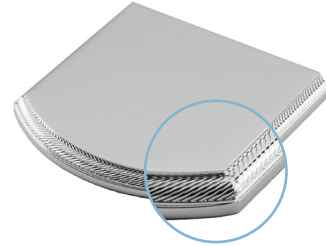

BEVEL EDGE

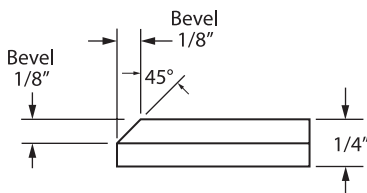

SLAB EDGE

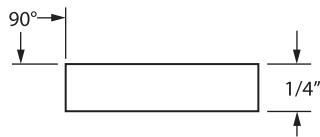

ROLLED EDGE

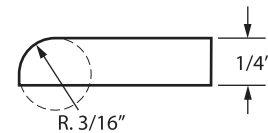
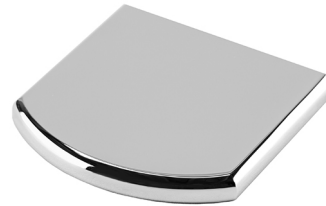

HOW TO ORDER

- Select correct series of profile required (i.e. EYEBROW or SQUARE).
- Specify EDGE DETAIL — CHAUTAUQUA edge option is standard. If alternate EDGE DETAIL is required — make sure to specify as SUB (example — SUB ROPE).
- If necessary, calculate the appropriate upcharge **per lineal inch** for COIN or ROPE (see retail price list).

REMEMBER

- Custom escutcheon sizes are available.
- Standard escutcheon thickness is 1/4" — alternate thickness available upon request.
- Contact us to discuss custom edge details or profiles.

CLASSIC BRASS

JAMESTOWN, NEW YORK

SIGNATURE FINISHES

SOLID BRASS FINISHES



ANTIQUE BRASS
(AB)



ANTIQUE BURNISHED
BRASS (ABB)



ANTIQUE BURNISHED
NICKEL (ABN)



ANTIQUE NICKEL
(AN)



ANTIQUE POLISHED
SILVER (APS)



BURNISHED BRASS
(BB)



BURNISHED NICKEL
(BN)



OIL RUBBED
BRONZE (BZ)



KENSINGTON
(KN)



MATTE BLACK
(MB)



POLISHED ANTIQUE
(PA)



POLISHED ANTIQUE
NO LACQUER (PANL)



POLISHED BRASS
(PB)



POLISHED BRASS
NO LACQUER (PBNL)



POLISHED CHROME
(PC)



POLISHED GOLD
(PG)



POLISHED NICKEL
(PN)



POLISHED SILVER
(PS)



REVERE BRASS
(RB)



REVERE NICKEL
(RN)



REVERE TARNISHED
(RT)



SATIN BRASS
(SB)



SATIN BRASS
NO LACQUER (SBNL)



SATIN GOLD
(SG)



SATIN NICKEL
(SN)



SATIN SILVER
(SS)



SATIN TARNISHED
(STN)



TARNISHED
(TN)



WEATHERED ANTIQUE
NICKEL (WA)



WEATHERED BRASS
(WB)



WEATHERED BRONZE
(WZ)



WEATHERED COPPER
(WC)



WEATHERED NICKEL
(WN)

LEVEL 1

Antique Brass (AB)
Antique Burnished Brass (ABB)
Burnished Brass (BB)
Oil Rubbed Bronze (BZ)
Kensington (KN)
Polished Antique (PA)
Polished Antique — No Lacquer (PANL)
Polished Brass (PB)
Polished Brass — No Lacquer (PBNL)
Revere Brass (RB)
Revere Tarnished (RT)
Satin Brass (SB)
Satin Brass — No Lacquer (SBNL)
Tarnished (TN)
Weathered Brass (WB)
Weathered Bronze (WZ)

LEVEL 2

Antique Burnished Nickel (ABN)
Antique Nickel (AN)
Burnished Nickel (BN)
Matte Black (MB)
Polished Chrome (PC)
Polished Nickel (PN)
Revere Nickel (RN)
Satin Nickel (SN)
Weathered Antique Nickel (WA)
Weathered Copper (WC)
Weathered Nickel (WN)

LEVEL 3

Antique Polished Silver (APS)
Polished Silver (PS)
Satin Silver (SS)

PRICE ON REQUEST

Polished Gold (PG)
Satin Gold (SG)

Custom finishes available on request.