

CLASSIC BRASS

JAMESTOWN, NEW YORK

ENTRANCE KNOB SETS

CHAUTAUQUA COLLECTION



ENTRANCE KNOB SETS

APPLICATIONS

13116 Knob Mortise Entrance Set

13117 Knob Mortise Entrance Set - FULL DUMMY

13118 Knob Latch x Auxiliary Deadbolt Set

13119 Knob Latch x Auxiliary Deadbolt Set - FULL DUMMY

Above sets include 14460 Knob

DIMENSIONS

Interior Escutcheon 2-1/2" x 12"

Exterior Escutcheon 2-1/2" x 12"

MATERIALS

Solid Brass

SPINDLES

8mm SQ (standard)

HOW TO ORDER

1. Specify application.
2. Specify finish. If split finish is required, please indicate exterior/interior.
3. Specify door thickness. Standard thickness is 1-3/4".
4. Specify hand of door - RH/LH.
5. Specify backset.
 - standard for mortise lock is 2-1/2".
 - standard for auxiliary deadbolt is 2-3/8".

REMEMBER

1. All knobs are interchangeable.
2. Standard mortise lock is 2-1/2" EE. Specify 2-3/4" if required.
3. Standard latch x auxiliary deadbolt: 5-1/2" c-c spacing and 2-3/8" backset. If required, specify 2-3/4" backset.
4. A door thickness greater than 1-3/4" will require a #9901 thick door kit for mortise application.
5. Custom escutcheon sizes and drilling available.
6. Chautauqua SQUARE and EYEBROW edge profiles are standard. Additional edge details available.
7. Concealed undermount attachment is standard on the exterior escutcheon. Oval slot head machine screws (2/ea) are standard on the interior escutcheon.

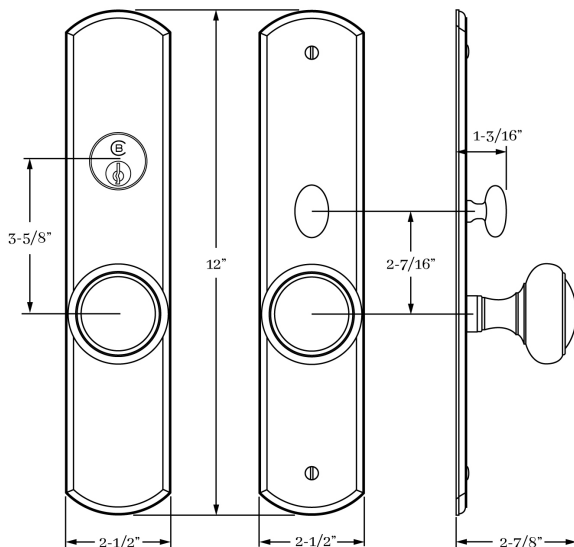

SET COMPONENTS

Entrance Knob Set - Mortise Lock includes exterior plate, interior plate with turnpiece, two knobs, 4" swivel spindle (8mm), Accurate 9124 K x K mortise lock (2-1/2" backset), faceplate, strike 1-1/4" LTC, dust box, mortise cylinder and mounting hardware.

Entrance Knob Set - Latch x Auxiliary Deadbolt includes an exterior plate, interior plate with turnpiece, two knobs, passage latch K x K (2-3/8" backset), 4" straight spindle (8mm), auxiliary deadbolt (2-3/8" backset), rim cylinder, latch faceplate, full lip strike, dust boxes and mounting hardware. NOTE: our standard spacing between knob hub and auxiliary deadbolt is 5-1/2" c-c.

Entrance Knob Set - FULL DUMMY includes exterior plate, interior plate, two knobs, 4" straight spindle (8mm) and full dummy mounting hardware.

EYEBROW ESCUTCHEON
EDGE OPTIONS

CHAUTAQUA EDGE
Standard

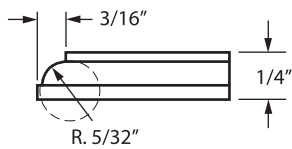
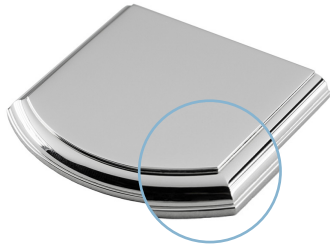

COIN EDGE

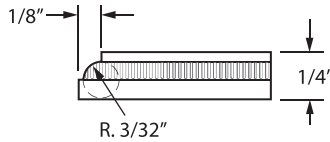
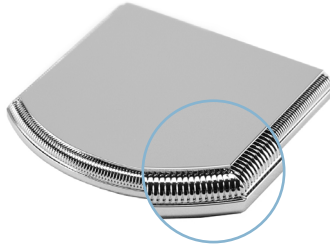

ROPE EDGE

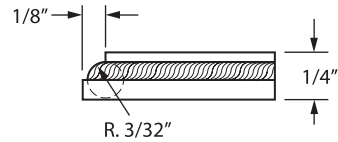
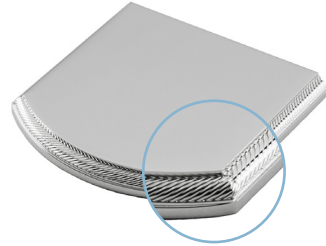

BEVEL EDGE

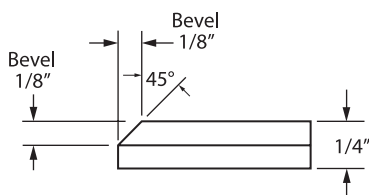

SLAB EDGE

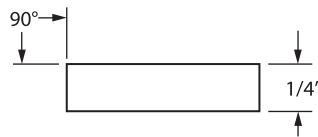

ROLLED EDGE

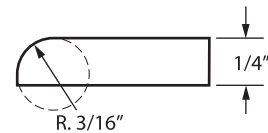
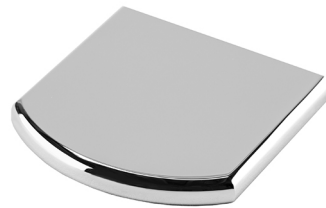

HOW TO ORDER

- Select correct series of profile required (i.e. EYEBROW or SQUARE).
- Specify EDGE DETAIL – CHAUTAUQUA edge option is standard. If alternate EDGE DETAIL is required – make sure to specify as SUB (example – SUB ROPE).
- If necessary, calculate the appropriate upcharge **per lineal inch** for COIN or ROPE (see retail price list).

REMEMBER

- Custom escutcheon sizes are available.
- Standard escutcheon thickness is 1/4" – alternate thickness available upon request.
- Contact us to discuss custom edge details or profiles.

CLASSIC BRASS

JAMESTOWN, NEW YORK

SIGNATURE FINISHES

SOLID BRASS FINISHES



ANTIQUE BRASS
(AB)



ANTIQUE BURNISHED
BRASS (ABB)



ANTIQUE BURNISHED
NICKEL (ABN)



ANTIQUE NICKEL
(AN)



ANTIQUE POLISHED
SILVER (APS)



BURNISHED BRASS
(BB)



BURNISHED NICKEL
(BN)



OIL RUBBED
BRONZE (BZ)



KENSINGTON
(KN)



MATTE BLACK
(MB)



POLISHED ANTIQUE
(PA)



POLISHED ANTIQUE
NO LACQUER (PANL)



POLISHED BRASS
(PB)



POLISHED BRASS
NO LACQUER (PBNL)



POLISHED CHROME
(PC)



POLISHED GOLD
(PG)



POLISHED NICKEL
(PN)



POLISHED SILVER
(PS)



REVERE BRASS
(RB)



REVERE NICKEL
(RN)



REVERE TARNISHED
(RT)



SATIN BRASS
(SB)



SATIN BRASS
NO LACQUER (SBNL)



SATIN GOLD
(SG)



SATIN NICKEL
(SN)



SATIN SILVER
(SS)



SATIN TARNISHED
(STN)



TARNISHED
(TN)



WEATHERED ANTIQUE
NICKEL (WA)



WEATHERED BRASS
(WB)



WEATHERED BRONZE
(WZ)



WEATHERED COPPER
(WC)



WEATHERED NICKEL
(WN)

LEVEL 1

Antique Brass (AB)
Antique Burnished Brass (ABB)
Burnished Brass (BB)
Oil Rubbed Bronze (BZ)
Kensington (KN)
Polished Antique (PA)
Polished Antique — No Lacquer (PANL)
Polished Brass (PB)
Polished Brass — No Lacquer (PBNL)
Revere Brass (RB)
Revere Tarnished (RT)
Satin Brass (SB)
Satin Brass — No Lacquer (SBNL)
Tarnished (TN)
Weathered Brass (WB)
Weathered Bronze (WZ)

LEVEL 2

Antique Burnished Nickel (ABN)
Antique Nickel (AN)
Burnished Nickel (BN)
Matte Black (MB)
Polished Chrome (PC)
Polished Nickel (PN)
Revere Nickel (RN)
Satin Nickel (SN)
Weathered Antique Nickel (WA)
Weathered Copper (WC)
Weathered Nickel (WN)

LEVEL 3

Antique Polished Silver (APS)
Polished Silver (PS)
Satin Silver (SS)

PRICE ON REQUEST

Polished Gold (PG)
Satin Gold (SG)

Custom finishes available on request.