

# CLASSIC BRASS

JAMESTOWN, NEW YORK

## INTERIOR LEVER SETS

---

CHAUTAUQUA COLLECTION



# INTERIOR LEVER SETS

## 2" ROSE SETS

- 16461 Lever Set - PASSAGE
- 16462 Lever Set - PRIVACY
- 16463 Lever Set - SECTIONAL PRIVACY
- 16464 Lever Set - FULL DUMMY
- 16465 Lever Set - HALF DUMMY

- 16468 Lever Mortise Set - PASSAGE
- 16469 Lever Mortise Set - PRIVACY

## 2-9/16" ROSE SETS

- 16471 Lever Set - PASSAGE
- 16472 Lever Set - PRIVACY
- 16473 Lever Set - SECTIONAL PRIVACY
- 16474 Lever Set - FULL DUMMY
- 16475 Lever Set - HALF DUMMY

- 16460 Lever Only 4-1/2"
- 14089 Rose Only 2"
- 14099 Rose Only 2-9/16"

## MATERIALS

Solid Brass

## SPINDLES

8mm SQ (standard)

## HOW TO ORDER

1. Specify application.
2. Specify if pre-drilled adapters are required (part #9749).
3. Specify finish. If split finish is required, please indicate exterior/interior.
4. Specify door thickness. Standard thickness is 1-3/8".
5. Specify backset.
  - standard is 2-3/8" for tubular.
  - standard is 2-1/2" for mortise.
6. Specify hand of door - RH/LH for mortise applications.

## REMEMBER

1. Specify pre-drilled adapter (#9749) for 2-1/8" pre-drilled doors, which requires the large rose.
2. Specify interior mortise lock for quality installations.
3. All knobs and levers are interchangeable.
4. FULL LIP strikes are standard. Specify SUB "T" strike, if required.
5. Standard backset is 2-3/8" for tubular. If required, specify 2-3/4". Standard backset is 2-1/2" for mortise. If required, specify 2-3/4".
6. A door thickness greater than 1-3/4" will require a #9900 thick door kit for mortise application.
7. Combination strike and faceplate available for sectional tubular privacy function.

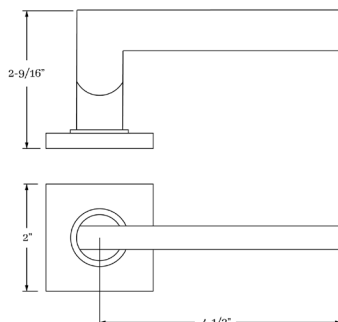

## SET COMPONENTS

**Lever Set - PASSAGE** includes two rosettes (passage), two levers, passage latch L x L (2-3/8" backset), full lip strike, latch faceplate, 4" straight spindle (8mm), two rosette mount plates, two rosette mount plate hubs, dust box and mounting hardware. NOTE: if required, order pre-drilled adapter (part #9749) separately.

**Lever Set - PRIVACY** includes two rosettes (privacy), two levers, privacy latch L x L (2-3/8" backset), full lip strike, latch faceplate, 4" swivel spindle (8mm), two rosette mount plates, two rosette mount plate hubs, privacy pin, dust box and mounting hardware. NOTE: if required, order pre-drilled adapter (part #9749) separately.

**Lever Set - FULL DUMMY** includes two rosettes, two levers, 4" straight spindle (8mm), two dummy rosette mount plates, two rosette mount plate hubs and mounting hardware.

**Lever Set - HALF DUMMY** includes rosette, lever, dummy mount spindle, rosette mount plate hub and mounting hardware.

**Lever Mortise Set - PASSAGE** includes two rosettes, two levers, 4" straight spindle (8mm), Accurate 9825 L x L interior mortise lock (2-1/2" backset), strike, faceplate, dust box and mounting hardware.

**Lever Mortise Set - PRIVACY** includes two rosettes, two levers, turnpiece and backplate, emergency egress trim, 4" straight spindle (8mm), Accurate 9839 L x L interior mortise lock (2-1/2" backset), strike, faceplate, dust box and mounting hardware.

# CLASSIC BRASS

JAMESTOWN, NEW YORK

## SIGNATURE FINISHES

### SOLID BRASS FINISHES



ANTIQUE BRASS  
(AB)



ANTIQUE BURNISHED  
BRASS (ABB)



ANTIQUE BURNISHED  
NICKEL (ABN)



ANTIQUE NICKEL  
(AN)



ANTIQUE POLISHED  
SILVER (APS)



BURNISHED BRASS  
(BB)



BURNISHED NICKEL  
(BN)



OIL RUBBED  
BRONZE (BZ)



KENSINGTON  
(KN)



MATTE BLACK  
(MB)



POLISHED ANTIQUE  
(PA)



POLISHED ANTIQUE  
NO LACQUER (PANL)



POLISHED BRASS  
(PB)



POLISHED BRASS  
NO LACQUER (PBNL)



POLISHED CHROME  
(PC)



POLISHED GOLD  
(PG)



POLISHED NICKEL  
(PN)



POLISHED SILVER  
(PS)



REVERE BRASS  
(RB)



REVERE NICKEL  
(RN)



REVERE TARNISHED  
(RT)



SATIN BRASS  
(SB)



SATIN BRASS  
NO LACQUER (SBNL)



SATIN GOLD  
(SG)



SATIN NICKEL  
(SN)



SATIN SILVER  
(SS)



SATIN TARNISHED  
(STN)



TARNISHED  
(TN)



WEATHERED ANTIQUE  
NICKEL (WA)



WEATHERED BRASS  
(WB)



WEATHERED BRONZE  
(WZ)



WEATHERED COPPER  
(WC)



WEATHERED NICKEL  
(WN)

### LEVEL 1

Antique Brass (AB)  
Antique Burnished Brass (ABB)  
Burnished Brass (BB)  
Oil Rubbed Bronze (BZ)  
Kensington (KN)  
Polished Antique (PA)  
Polished Antique — No Lacquer (PANL)  
Polished Brass (PB)  
Polished Brass — No Lacquer (PBNL)  
Revere Brass (RB)  
Revere Tarnished (RT)  
Satin Brass (SB)  
Satin Brass — No Lacquer (SBNL)  
Tarnished (TN)  
Weathered Brass (WB)  
Weathered Bronze (WZ)

### LEVEL 2

Antique Burnished Nickel (ABN)  
Antique Nickel (AN)  
Burnished Nickel (BN)  
Matte Black (MB)  
Polished Chrome (PC)  
Polished Nickel (PN)  
Revere Nickel (RN)  
Satin Nickel (SN)  
Weathered Antique Nickel (WA)  
Weathered Copper (WC)  
Weathered Nickel (WN)

### LEVEL 3

Antique Polished Silver (APS)  
Polished Silver (PS)  
Satin Silver (SS)

### PRICE ON REQUEST

Polished Gold (PG)  
Satin Gold (SG)

Custom finishes available on request.