

# CLASSIC BRASS

JAMESTOWN, NEW YORK

## **KNOB SCREEN DOOR SET**

---

HUTTER COLLECTION



# KNOB SCREEN DOOR SET

## APPLICATIONS

7896 Knob Screen Door Set - PASSAGE  
7897 Knob Screen Door Set - PATIO  
7382 Knob Screen Door Set - FULL DUMMY  
Above sets include 4382 Knob

## PRODUCT DIMENSIONS

Knob 1-3/4"  
Escutcheon 1-1/2" x 6"

## MATERIALS

Solid Brass

## HOW TO ORDER

1. Specify application.
2. Specify finish. If split finish is required, please indicate exterior/interior.
3. Specify backset. Standard is 2".
4. Specify door thickness.
5. Specify hand of door - RH/LH.

## REMEMBER

1. Standard backset is 2". Specify 1-1/2" or 1-3/4" backset if required.
2. Custom escutcheon sizes and drilling available.
3. HUTTER ARCH edge profile is standard. SQUARE CORNER and OFFSET edge options available.

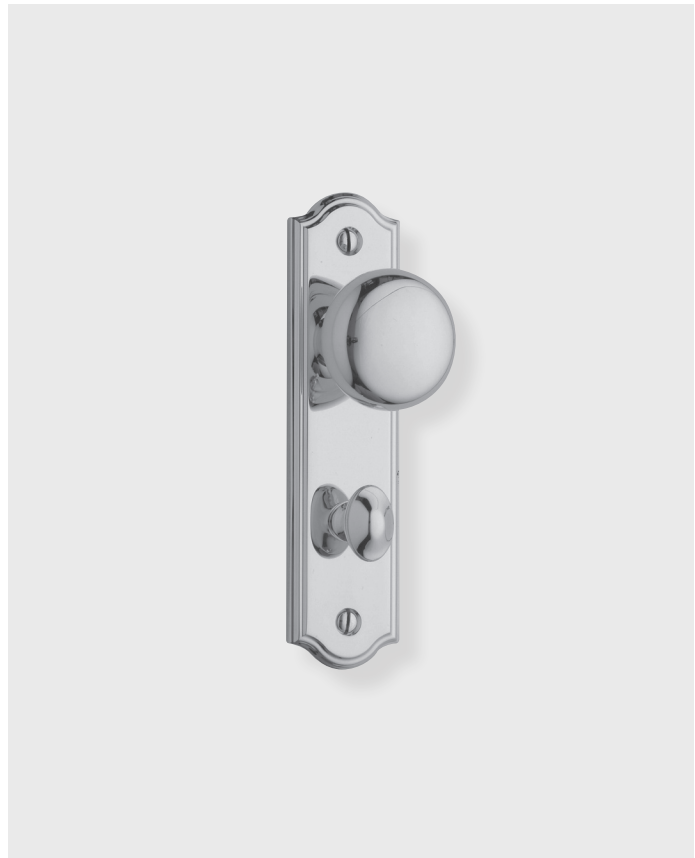

HUTTER | DOOR

## SET COMPONENTS

**Screen Door Knob Set - PASSAGE** includes two escutcheons, two knobs, straight spindle (8mm), Accurate 6525 K x K screen door mortise lock (2" backset), strike, faceplate, dust box and mounting hardware.

**Screen Door Knob Set - PATIO** includes an exterior escutcheon, an interior escutcheon with turnpiece attached, two knobs, straight spindle (8mm), Accurate 6539 K x K screen door mortise lock (2" backset), strike, faceplate, dust box and mounting hardware.

**Screen Door Knob Set - FULL DUMMY** includes two escutcheons, two knobs, straight spindle (8mm), two dummy mount plates and mounting hardware.

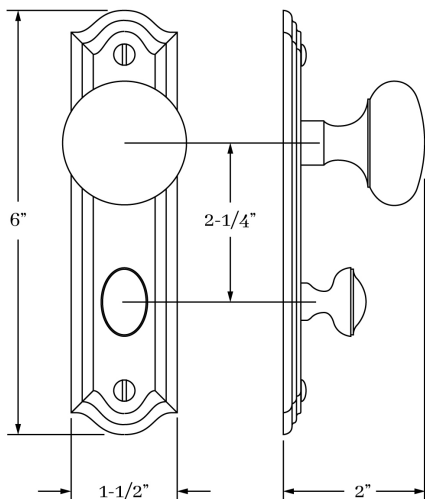

CLASSIC BRASS

JAMESTOWN, NEW YORK

ARCH ESCUTCHEON  
EDGE OPTIONS

**HUTTER ARCH EDGE**  
Standard

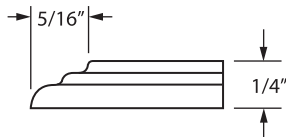
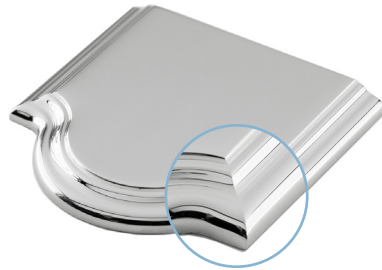

**OFFSET ARCH EDGE**

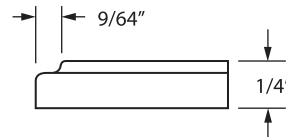
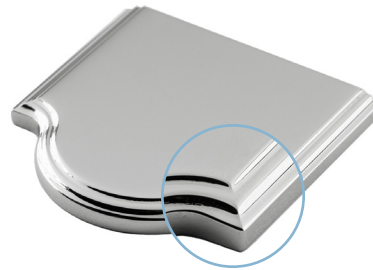

**LAKEWOOD ARCH EDGE**

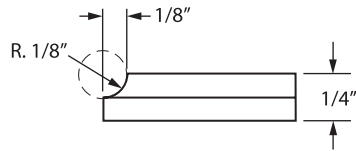
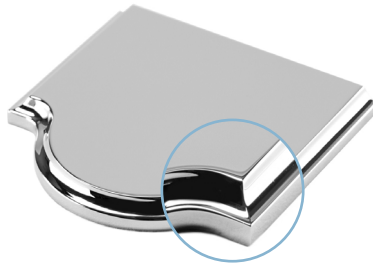

**JAMESTOWN ARCH EDGE**

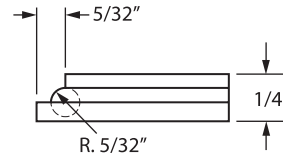
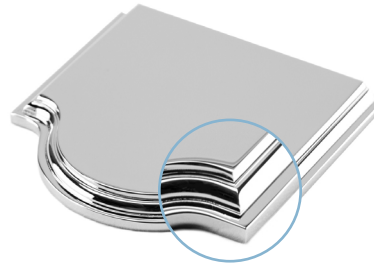

**HOW TO ORDER**

- Specify EDGE DETAIL — Hutter ARCH option is standard. If alternate EDGE DETAIL is required — make sure to specify as SUB (example — SUB OFFSET ARCH).

**REMEMBER**

- Custom escutcheon sizes are available.
- Standard escutcheon thickness is 1/4" — alternate thickness available upon request.
- Contact us to discuss custom edge details or profiles.

SQUARE ESCUTCHEON  
EDGE OPTIONS

HUTTER SQUARE EDGE

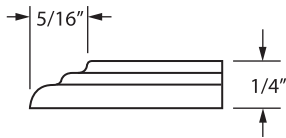
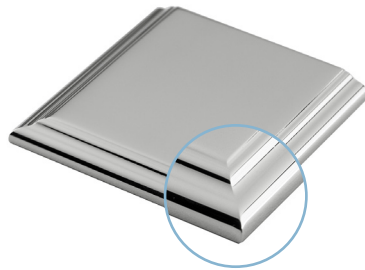

OFFSET SQUARE EDGE

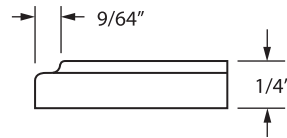
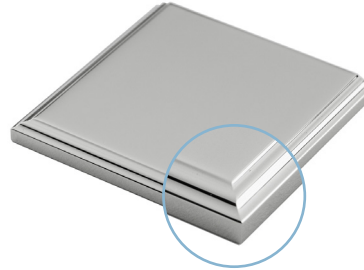

LAKEWOOD SQUARE EDGE

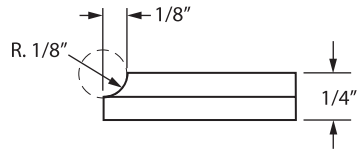
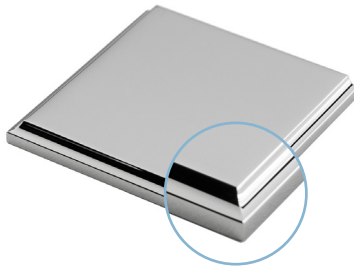

JAMESTOWN SQUARE EDGE

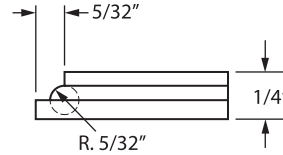
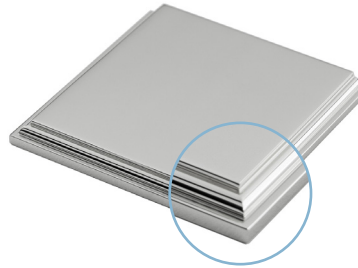

HOW TO ORDER

- Hutter ARCH profile is standard. If SQUARE profile required, please specify as SUB (example – SUB SQUARE).
- Specify EDGE DETAIL – Hutter ARCH option is standard. If alternate EDGE DETAIL is required – make sure to specify as SUB (example – SUB OFFSET ARCH).

REMEMBER

- Custom escutcheon sizes are available.
- Standard escutcheon thickness is 1/4" – alternate thickness available upon request.
- Contact us to discuss custom edge details or profiles.

# CLASSIC BRASS

JAMESTOWN, NEW YORK

## SIGNATURE FINISHES

### SOLID BRASS FINISHES



ANTIQUE BRASS  
(AB)



ANTIQUE BURNISHED  
BRASS (ABB)



ANTIQUE BURNISHED  
NICKEL (ABN)



ANTIQUE NICKEL  
(AN)



ANTIQUE POLISHED  
SILVER (APS)



BURNISHED BRASS  
(BB)



BURNISHED NICKEL  
(BN)



OIL RUBBED  
BRONZE (BZ)



KENSINGTON  
(KN)



MATTE BLACK  
(MB)



POLISHED ANTIQUE  
(PA)



POLISHED ANTIQUE  
NO LACQUER (PANL)



POLISHED BRASS  
(PB)



POLISHED BRASS  
NO LACQUER (PBNL)



POLISHED CHROME  
(PC)



POLISHED GOLD  
(PG)



POLISHED NICKEL  
(PN)



POLISHED SILVER  
(PS)



REVERE BRASS  
(RB)



REVERE NICKEL  
(RN)



REVERE TARNISHED  
(RT)



SATIN BRASS  
(SB)



SATIN BRASS  
NO LACQUER (SBNL)



SATIN GOLD  
(SG)



SATIN NICKEL  
(SN)



SATIN SILVER  
(SS)



SATIN TARNISHED  
(STN)



TARNISHED  
(TN)



WEATHERED ANTIQUE  
NICKEL (WA)



WEATHERED BRASS  
(WB)



WEATHERED BRONZE  
(WZ)



WEATHERED COPPER  
(WC)



WEATHERED NICKEL  
(WN)

### LEVEL 1

Antique Brass (AB)  
Antique Burnished Brass (ABB)  
Burnished Brass (BB)  
Oil Rubbed Bronze (BZ)  
Kensington (KN)  
Polished Antique (PA)  
Polished Antique — No Lacquer (PANL)  
Polished Brass (PB)  
Polished Brass — No Lacquer (PBNL)  
Revere Brass (RB)  
Revere Tarnished (RT)  
Satin Brass (SB)  
Satin Brass — No Lacquer (SBNL)  
Tarnished (TN)  
Weathered Brass (WB)  
Weathered Bronze (WZ)

### LEVEL 2

Antique Burnished Nickel (ABN)  
Antique Nickel (AN)  
Burnished Nickel (BN)  
Matte Black (MB)  
Polished Chrome (PC)  
Polished Nickel (PN)  
Revere Nickel (RN)  
Satin Nickel (SN)  
Weathered Antique Nickel (WA)  
Weathered Copper (WC)  
Weathered Nickel (WN)

### LEVEL 3

Antique Polished Silver (APS)  
Polished Silver (PS)  
Satin Silver (SS)

### PRICE ON REQUEST

Polished Gold (PG)  
Satin Gold (SG)

Custom finishes available on request.