

# CLASSIC BRASS

JAMESTOWN, NEW YORK

## LEVER AND ESCUTCHEON

---

FIFTH AVENUE COLLECTION



# LEVER AND ESCUTCHEON

## 2" X 12" ESCUTCHEON SETS

7627 Lever Escutcheon Set - PASSAGE

7629 Lever Escutcheon Set - LATCH x M/B

7630 Lever Escutcheon Set - FULL DUMMY

7631 Lever Escutcheon Set - HALF DUMMY

Above sets include 7773 Lever

## 2-1/2" X 14" ESCUTCHEON SETS

7642 Lever Escutcheon Set - PASSAGE

7643 Lever Escutcheon Set - PRIVACY

7644 Lever Escutcheon Set - LATCH x M/B

7645 Lever Escutcheon Set - FULL DUMMY

7646 Lever Escutcheon Set - HALF DUMMY

Above sets include 7773 Lever

## MATERIALS

Solid Brass

## SPINDLES

8mm SQ (standard)

## HOW TO ORDER

1. Specify application.
2. Specify finish. If split finish is required, please indicate exterior/interior.
3. Specify door thickness. Standard thickness is 1-3/4".
4. Specify hand of door - RH/LH.
5. Specify backset.
  - standard is 2-3/8" for tubular.
  - standard is 2-1/2" for mortise.

## REMEMBER

1. All levers are interchangeable.
2. FULL LIP strikes are standard. Specify SUB "T" strike, if required.
3. Standard backset is 2-3/8" for tubular. If required, specify 2-3/4".
4. A door thickness greater than 1-3/4" will require a #9900 thick door kit for mortise application.
5. Custom escutcheon sizes and drilling available.
6. ONE STEP edge profile is standard. Specify TWO STEP, BEVEL or SLAB edge profile if required.
7. Combination strike and faceplate available for latch x mortise bolt function.
8. Oval slot head wood screws (4/ea) are standard on the escutcheons.

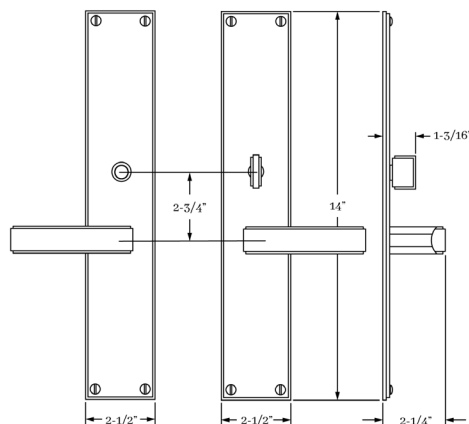

## SET COMPONENTS

**Lever Escutcheon Set - PASSAGE** includes two escutcheons, two levers, 4" straight spindle (8mm), passage latch L x L (2-3/8" backset), faceplate, full lip strike, dust box and mounting hardware.

**Lever Escutcheon Set - PRIVACY** includes two escutcheons with privacy pin hole, two levers, 4" swivel spindle (8mm), privacy latch L x L (2-3/8" backset), privacy pin, faceplate, full lip strike, dust box and mounting hardware.

**Lever Escutcheon Set - LATCH x MORTISE BOLT** includes an exterior escutcheon w/ EE hole, an interior escutcheon w/ turnpiece attached, two levers, 4" straight spindle (8mm), passage latch L x L (2-3/8" backset) latch faceplate, full lip strike, mortise bolt (2-3/8" backset), mortise bolt faceplate, mortise bolt strike, dust boxes and mounting hardware. NOTE: our standard spacing between lever hub and mortise bolt is 2-3/4".

**Lever Escutcheon Set - FULL DUMMY** includes two escutcheons, two levers, 4" straight spindle (8mm), two dummy mounting plates and mounting hardware.

**Lever Escutcheon Set - HALF DUMMY** includes an escutcheon, lever, dummy mount spindle and mounting hardware.

SQUARE ESCUTCHEON  
EDGE OPTIONS

**ONE STEP EDGE**  
Standard

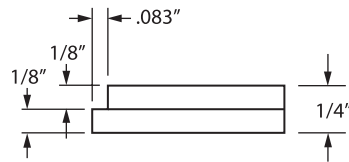
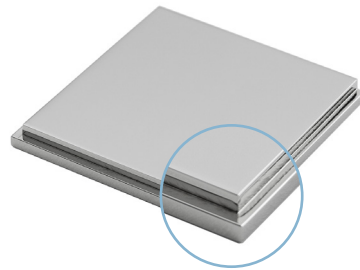

**TWO STEP EDGE**

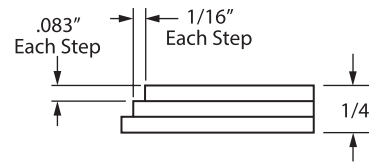
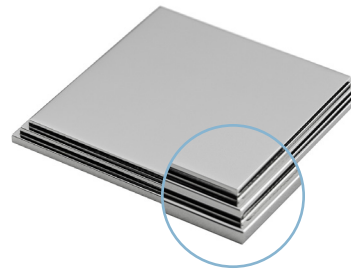

**BEVEL EDGE**

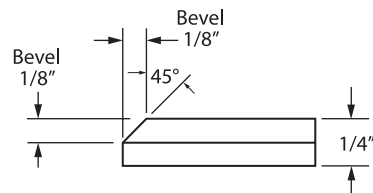
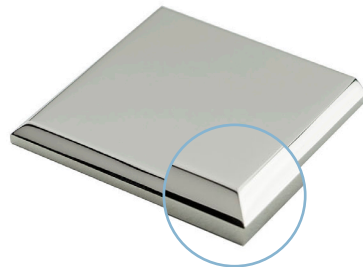

**SLAB EDGE**

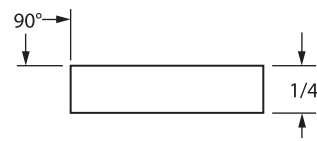

**HOW TO ORDER**

- Specify EDGE DETAIL — ONE STEP edge option is standard. If alternate EDGE DETAIL is required — make sure to specify as SUB (example — SUB BEVEL).

**REMEMBER**

- Custom escutcheon sizes are available.
- Standard escutcheon thickness is 1/4" — alternate thickness available upon request.
- Contact us to discuss custom edge details or profiles.

# CLASSIC BRASS

JAMESTOWN, NEW YORK

## SIGNATURE FINISHES

### SOLID BRASS FINISHES



ANTIQUE BRASS  
(AB)



ANTIQUE BURNISHED  
BRASS (ABB)



ANTIQUE BURNISHED  
NICKEL (ABN)



ANTIQUE NICKEL  
(AN)



ANTIQUE POLISHED  
SILVER (APS)



BURNISHED BRASS  
(BB)



BURNISHED NICKEL  
(BN)



OIL RUBBED  
BRONZE (BZ)



KENSINGTON  
(KN)



MATTE BLACK  
(MB)



POLISHED ANTIQUE  
(PA)



POLISHED ANTIQUE  
NO LACQUER (PANL)



POLISHED BRASS  
(PB)



POLISHED BRASS  
NO LACQUER (PBNL)



POLISHED CHROME  
(PC)



POLISHED GOLD  
(PG)



POLISHED NICKEL  
(PN)



POLISHED SILVER  
(PS)



REVERE BRASS  
(RB)



REVERE NICKEL  
(RN)



REVERE TARNISHED  
(RT)



SATIN BRASS  
(SB)



SATIN BRASS  
NO LACQUER (SBNL)



SATIN GOLD  
(SG)



SATIN NICKEL  
(SN)



SATIN SILVER  
(SS)



SATIN TARNISHED  
(STN)



TARNISHED  
(TN)



WEATHERED ANTIQUE  
NICKEL (WA)



WEATHERED BRASS  
(WB)



WEATHERED BRONZE  
(WZ)



WEATHERED COPPER  
(WC)



WEATHERED NICKEL  
(WN)

### LEVEL 1

Antique Brass (AB)  
Antique Burnished Brass (ABB)  
Burnished Brass (BB)  
Oil Rubbed Bronze (BZ)  
Kensington (KN)  
Polished Antique (PA)  
Polished Antique — No Lacquer (PANL)  
Polished Brass (PB)  
Polished Brass — No Lacquer (PBNL)  
Revere Brass (RB)  
Revere Tarnished (RT)  
Satin Brass (SB)  
Satin Brass — No Lacquer (SBNL)  
Tarnished (TN)  
Weathered Brass (WB)  
Weathered Bronze (WZ)

### LEVEL 2

Antique Burnished Nickel (ABN)  
Antique Nickel (AN)  
Burnished Nickel (BN)  
Matte Black (MB)  
Polished Chrome (PC)  
Polished Nickel (PN)  
Revere Nickel (RN)  
Satin Nickel (SN)  
Weathered Antique Nickel (WA)  
Weathered Copper (WC)  
Weathered Nickel (WN)

### LEVEL 3

Antique Polished Silver (APS)  
Polished Silver (PS)  
Satin Silver (SS)

### PRICE ON REQUEST

Polished Gold (PG)  
Satin Gold (SG)

Custom finishes available on request.