

CLASSIC BRASS

JAMESTOWN, NEW YORK

INTERIOR LEVER SETS

APRÈS COLLECTION

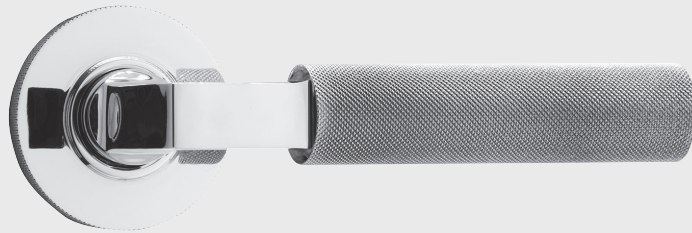

INTERIOR LEVER SETS

2" ROSE SETS

17362 Lever Set - PASSAGE

17363 Lever Set - PRIVACY

17364 Lever Set - SECTIONAL PRIVACY

17365 Lever Set - FULL DUMMY

17366 Lever Set - HALF DUMMY

17367 Lever Mortise Set - PASSAGE

17368 Lever Mortise Set - PRIVACY

2-1/2" ROSE SETS

17372 Lever Set - PASSAGE

17373 Lever Set - PRIVACY

17374 Lever Set - SECTIONAL PRIVACY

17375 Lever Set - FULL DUMMY

17376 Lever Set - HALF DUMMY

17360 Lever Only 4-7/16"

17378 Diamond Rose Only 2"

17179 Diamond Rose Only 2-1/2"

MATERIALS

Solid Brass

SPINDLES

8mm SQ (standard)

HOW TO ORDER

1. Specify application.
2. Specify if pre-drilled adapters are required (part #9749).
3. Specify finish. If split finish is required, please indicate exterior/interior.
4. Specify door thickness. Standard thickness is 1-3/8".
5. Specify backset.
 - standard is 2-3/8" for tubular.
 - standard is 2-1/2" for mortise.
6. Specify hand of door - RH/LH for mortise applications.

REMEMBER

1. Specify pre-drilled adapter (#9749) for 2-1/8" pre-drilled doors, which requires the large rose.
2. Specify interior mortise lock for quality installations.
3. All knobs and levers are interchangeable.
4. FULL LIP strikes are standard. Specify SUB "T" strike, if required.
5. A door thickness greater than 1-3/4" will require a #9900 thick door kit for mortise application.
6. SLAB edge is standard. Specify COIN or CROSS HATCH edge detail if required.
7. Combination strike and faceplate available for sectional tubular privacy function.

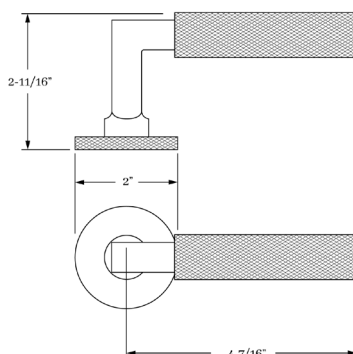

APRÈS | DOOR

SET COMPONENTS

Lever Set - PASSAGE includes two rosettes (passage), two levers, passage latch L x L (2-3/8" backset), full lip strike, latch faceplate, 4" straight spindle (8mm), two rosette mount plates, two rosette mount plate hubs, dust box and mounting hardware. NOTE: if required, order pre-drilled adapter (part #9749) separately.

Lever Set - PRIVACY includes two rosettes (privacy), two levers, privacy latch L x L (2-3/8" backset), full lip strike, latch faceplate, 4" swivel spindle (8mm), two rosette mount plates, two rosette mount plate hubs, privacy pin, dust box and mounting hardware. NOTE: if required, order pre-drilled adapter (part #9749) separately.

Lever Set - FULL DUMMY includes two rosettes, two levers, 4" straight spindle (8mm), two dummy rosette mount plates, two rosette mount plate hubs and mounting hardware.

Lever Set - HALF DUMMY includes rosette, lever, dummy mount spindle, rosette mount plate hub and mounting hardware.

Lever Mortise Set - PASSAGE includes two rosettes, two levers, 4" straight spindle (8mm), Accurate 9825 L x L interior mortise lock (2-1/2" backset), strike, faceplate, dust box and mounting hardware.

Lever Mortise Set - PRIVACY includes two rosettes, two levers, turnpiece and backplate, emergency egress trim, 4" straight spindle (8mm), Accurate 9839 L x L interior mortise lock (2-1/2" backset), strike, faceplate, dust box and mounting hardware.

CLASSIC BRASS

JAMESTOWN, NEW YORK

SQUARE ESCUTCHEON
EDGE OPTIONS

SLAB EDGE
Standard

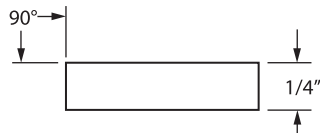

SLAB CROSS HATCH EDGE

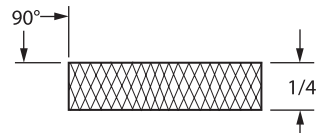
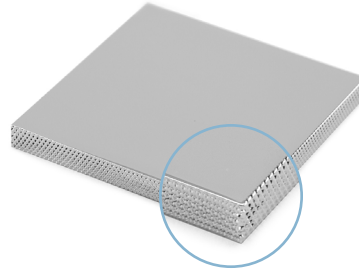

SLAB COIN EDGE

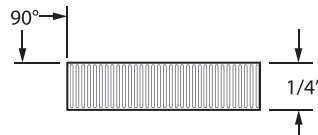
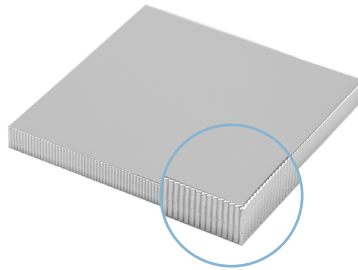

HOW TO ORDER

- Specify EDGE DETAIL — SLAB edge option is standard. If alternate EDGE DETAIL is required — make sure to specify as SUB (example — SUB COIN).
- If necessary, calculate the appropriate upcharge **per lineal inch** for COIN or CROSS HATCH (see retail price list).

REMEMBER

- Custom escutcheon sizes are available.
- Standard escutcheon thickness is 1/4" — alternate thickness available upon request.
- Contact us to discuss custom edge details or profiles.

CLASSIC BRASS

JAMESTOWN, NEW YORK

SIGNATURE FINISHES

SOLID BRASS FINISHES



ANTIQUE BRASS
(AB)



ANTIQUE BURNISHED
BRASS (ABB)



ANTIQUE BURNISHED
NICKEL (ABN)



ANTIQUE NICKEL
(AN)



ANTIQUE POLISHED
SILVER (APS)



BURNISHED BRASS
(BB)



BURNISHED NICKEL
(BN)



OIL RUBBED
BRONZE (BZ)



KENSINGTON
(KN)



MATTE BLACK
(MB)



POLISHED ANTIQUE
(PA)



POLISHED ANTIQUE
NO LACQUER (PANL)



POLISHED BRASS
(PB)



POLISHED BRASS
NO LACQUER (PBNL)



POLISHED CHROME
(PC)



POLISHED GOLD
(PG)



POLISHED NICKEL
(PN)



POLISHED SILVER
(PS)



REVERE BRASS
(RB)



REVERE NICKEL
(RN)



REVERE TARNISHED
(RT)



SATIN BRASS
(SB)



SATIN BRASS
NO LACQUER (SBNL)



SATIN GOLD
(SG)



SATIN NICKEL
(SN)



SATIN SILVER
(SS)



SATIN TARNISHED
(STN)



TARNISHED
(TN)



WEATHERED ANTIQUE
NICKEL (WA)



WEATHERED BRASS
(WB)



WEATHERED BRONZE
(WZ)



WEATHERED COPPER
(WC)



WEATHERED NICKEL
(WN)

LEVEL 1

Antique Brass (AB)
Antique Burnished Brass (ABB)
Burnished Brass (BB)
Oil Rubbed Bronze (BZ)
Kensington (KN)
Polished Antique (PA)
Polished Antique — No Lacquer (PANL)
Polished Brass (PB)
Polished Brass — No Lacquer (PBNL)
Revere Brass (RB)
Revere Tarnished (RT)
Satin Brass (SB)
Satin Brass — No Lacquer (SBNL)
Tarnished (TN)
Weathered Brass (WB)
Weathered Bronze (WZ)

LEVEL 2

Antique Burnished Nickel (ABN)
Antique Nickel (AN)
Burnished Nickel (BN)
Matte Black (MB)
Polished Chrome (PC)
Polished Nickel (PN)
Revere Nickel (RN)
Satin Nickel (SN)
Weathered Antique Nickel (WA)
Weathered Copper (WC)
Weathered Nickel (WN)

LEVEL 3

Antique Polished Silver (APS)
Polished Silver (PS)
Satin Silver (SS)

PRICE ON REQUEST

Polished Gold (PG)
Satin Gold (SG)

Custom finishes available on request.